

Technical Data Sheet

Wall Support - Heavy Duty Mounting Angle
Hot Dip Galvanized According To EN ISO 1461



Master Data

Product Code	078.SA100200
Description 1	Wall Support
Description 2	Heavy Duty Mounting Angle
Dimension	100 x 200mm
Material	Steel
Surface Protection	Hot Dip Galvanized Steel According To EN ISO 1461
Use	Outdoor / Wet Indoor Facilities
F in KN	1.00 KN

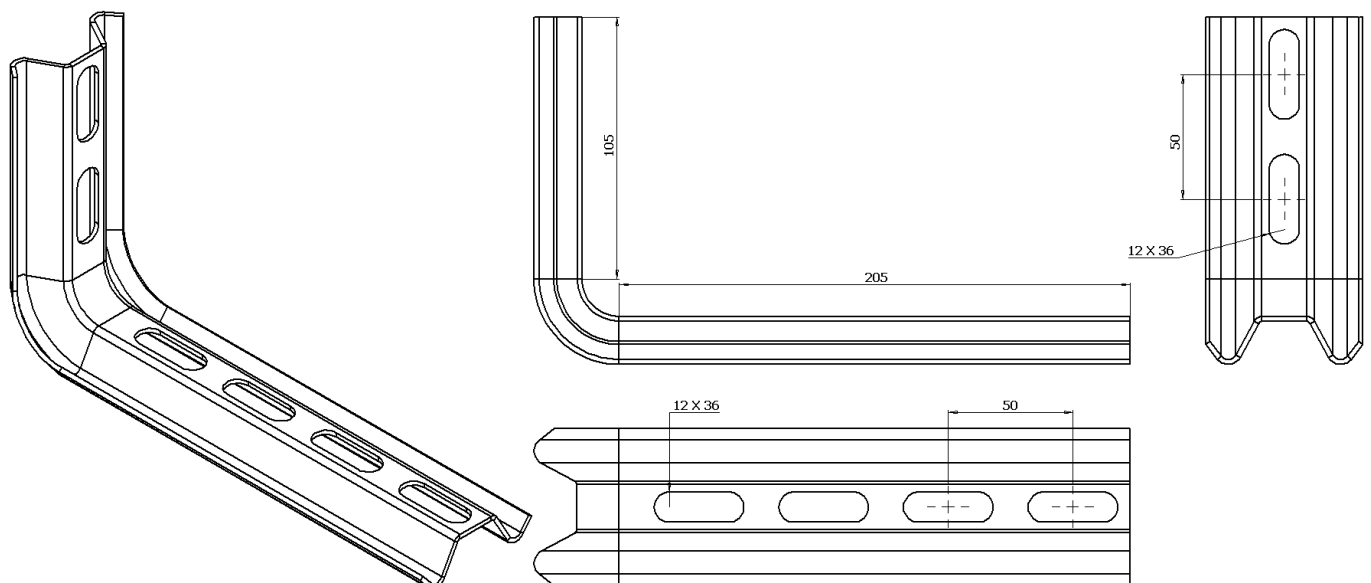

ISO 9001:2015